

# RESIDENTIAL BUILDING HANDBOOK

## 2021 International Residential Code (IRC)

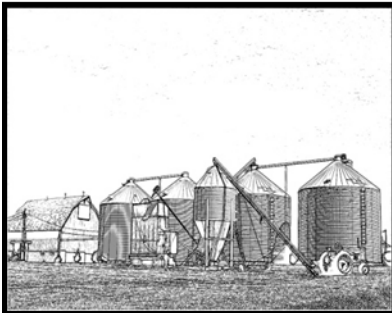

**MINNEHAHA COUNTY  
PLANNING & ZONING**  
415 N. Dakota Ave  
605-367-4204

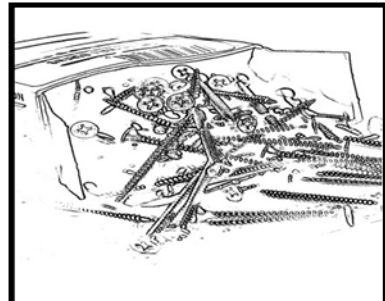
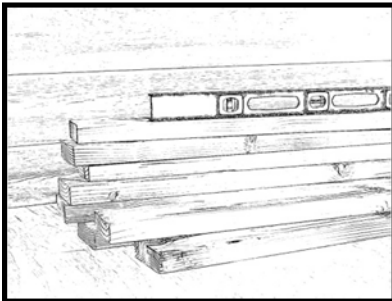

Strong Foundation. Strong Future.

*Legal Disclaimer:* The Residential Building Handbook is provided by the Minnehaha County Planning Department as an informational guide. The Residential Building Handbook should not be used as a substitute for codes and regulations. The applicant is responsible for compliance with all code and rule requirements, whether or not described in this handbook. This Handbook is also not intended as legal advice, or a substitute for legal advice. Questions about interpretation of the codes and regulations, as any other laws, should be referred to a private attorney.

## TABLE OF CONTENTS

Building Permits _____	4-5
Building Permit Fees _____	6
Setback Requirements _____	7-8
Residential Accessory Buildings _____	9
Doors _____	10
Emergency Escape & Rescue Openings _____	11-12
Window Glazing _____	13-14
Garages _____	15
Swimming Pools, Hot Tubs, & Spas _____	16-18
Security _____	19
Smoke Alarms/Carbon Monoxide Alarms _____	20-21
Stairways _____	22-25
Handrails _____	25-26
Ramps _____	27
Guards _____	28
Snow Loads & Climate & Geographic Design Criteria _____	29
Barrier-Free Accessibility _____	30
Common Residential Code Requirements _____	31-32
Driveway & Culvert Permits _____	33

## BUILDING PERMITS

**Permits Required.** Except as specified below, no building or structure shall be erected, constructed, enlarged, altered, repaired, moved, improved or converted unless a separate permit for each building or structure has first been obtained from the Planning Department.

**Posting of Permits:** The Permit placard (yellow card) shall be posted on the building near the main entrance or in front of the site or house, visible from the main road or entrance.

**Work exempt from permit.** Permits are not required for the following work. The work must still meet the provisions of the building code and other applicable ordinances.

1. One-story detached accessory structures, provided that the floor area does not exceed 120 square feet (11 m<sup>2</sup>). Such structures must still meet applicable setback requirements of the 1990 Revised Zoning Ordinance for Minnehaha County, the 2001 Revised Joint Zoning Ordinance for Minnehaha County and the City of Dell Rapids, and the Revised Joint Zoning Ordinance for Minnehaha County and the City of Sioux Falls.
2. Fences not over 6 feet (1829 mm) high. Fences must still meet applicable requirements of the 1990 Revised Zoning Ordinance for Minnehaha County, the 2001 Revised Joint Zoning Ordinance for Minnehaha County and the City of Dell Rapids, and the Revised Joint Zoning Ordinance for Minnehaha County and the City of Sioux Falls.
3. Retaining walls that are not over 4 feet (1219 mm) in height measured from the bottom of the grade elevation to the top of the wall, unless supporting a surcharge.
4. Water tanks supported directly upon grade if the capacity does not exceed 5,000 gallons (18,927 L) and the ratio of height to diameter or width does not exceed 2 to 1.
5. Sidewalks and driveways. A driveway permit may be required by the applicable road authority.
6. Painting, papering, tiling, carpeting, cabinets, counter tops and similar finish work.
7. Prefabricated swimming pools that are less than 18 inches (457 mm) deep.
8. Swings and other playground equipment.
9. Window awnings supported by an exterior wall that do not project more than 54 inches (1,372 mm) from the exterior wall and do not require additional support.
10. Uncovered decks not exceeding 200 square feet (18.58 m<sup>2</sup>) in area, that are not more than 30 inches (762 mm) above grade at any point, are not attached to a dwelling and do not serve the exit door required by Section R311.4. Such structures must still meet applicable setback requirements of the 1990 Revised Zoning Ordinance for Minnehaha County, the 2001 Revised Joint Zoning Ordinance for Minnehaha County and the City of Dell Rapids, and the Revised Joint Zoning Ordinance for Minnehaha County and the City of Sioux Falls.

## BUILDING PERMITS

**Work commencing before permit issuance.** If work is started before a building permit is issued, the permit fee will be doubled. The doubled fee may be applied for each week that the permit is not obtained. Such fees are in addition to the required permit fees. Legal and/or civil proceedings may also be commenced.

**Delinquent Accounts.** The Planning Department may refuse to issue permits or conduct inspections for any person or business whose account is delinquent.

**Required Inspections.** All construction work for which a permit is required is subject to inspection and all such construction or work must remain accessible and exposed for inspection purposes until approved. It is the responsibility of the permit applicant to cause the work to remain accessible and exposed for inspection purposes. Minnehaha County is not liable for expense entailed in the removal or replacement of any material required to allow the inspection.

- 1) Footing/Foundation inspections: to be made after excavations for footings are complete, forms and reinforcing steel including concrete encased electrode or UFER ground with a minimum of 2 inches of concrete cover are in place prior to pouring.
- 2) Framing Inspection: to be made after the roof, all framing, fire blocking, and bracing are in place and all pipes, chimneys and vents are complete and the rough electrical, plumbing and mechanical systems are in place.
- 3) Final Inspection: final inspection shall be made after the permitted work is complete and prior to occupancy.

The Building Inspector will either approved that portion of the construction as completed or will notify the permit holder or agent of the permit holder that changes are necessary for compliance to the adopted building enforcement code.

**Expiration.** Every permit issued shall become invalid 365 days after its issuance. The building official is authorized to grant, in writing, one extension of time, for a period not more than 180 days. The extension shall be requested in writing and any fees paid before the original permit expires.

## BUILDING PERMIT FEES

**Permit Fees.** A fee for each permit is based on the construction costs as adopted by Resolution by the Board of County Commissioners. The fee schedules for the issuance of a building permit shall be as follows:

### Dwellings - site built

Finished habitable space	\$95. <sup>55</sup> per square foot
Finished basements	\$60. <sup>90</sup> per square foot
Unfinished space (basement)	\$35. <sup>70</sup> per square foot
Attached garages	\$35. <sup>70</sup> per square foot
Detached garages, accessory structures, & decks	\$30. <sup>45</sup> per square foot

### Dwellings - moved

Finished habitable space	\$31. <sup>50</sup> per square foot
Finished basements	\$60. <sup>90</sup> per square foot
Unfinished space (basement)	\$35. <sup>70</sup> per square foot
Attached garages (moved on)	\$25. <sup>20</sup> per square foot
Detached garages & accessory structures (moved on)	\$12. <sup>60</sup> per square foot

### Manufactured and Mobile Homes

Finished habitable space	\$36. <sup>75</sup> per square foot
Finished basements	\$60. <sup>90</sup> per square foot
Unfinished space (basement and upper level)	\$35. <sup>70</sup> per square foot
Foundation (no basement)	\$12. <sup>60</sup> per square foot
Attached garages	\$35. <sup>70</sup> per square foot
Detached garages	\$30. <sup>45</sup> per square foot

Agricultural Structures \$24.<sup>15</sup> per square foot

1. Residential structures .....\$60.00 or .4% of construction costs, whichever is greater.
2. Commercial/Industrial structures. \$100.00 or 1% of construction costs, whichever is greater.
3. Agricultural structures.....\$30.00 or .2% of the construction costs, whichever is greater.

### Other Inspections and Fees.

- |  |         |
|--|---------|
| 1. Inspection outside of normal business hours, per hour* (*minimum charge—one hour)   | \$70.00 |
| 2. Inspections for which no fee is specifically indicated, per hour*   |         |
| (*minimum charge—one-half hour)  | \$70.00 |
| 3. Building Permit Extension (maximum 180 days)  | \$50.00 |
| 4. A mileage fee based on the current rate per mile authorized by the Internal Revenue Service shall be charged for any inspection occurring outside Minnehaha County. |         |

## MINIMUM SETBACK REQUIREMENTS (A-1, RR, RC Zoning Districts)

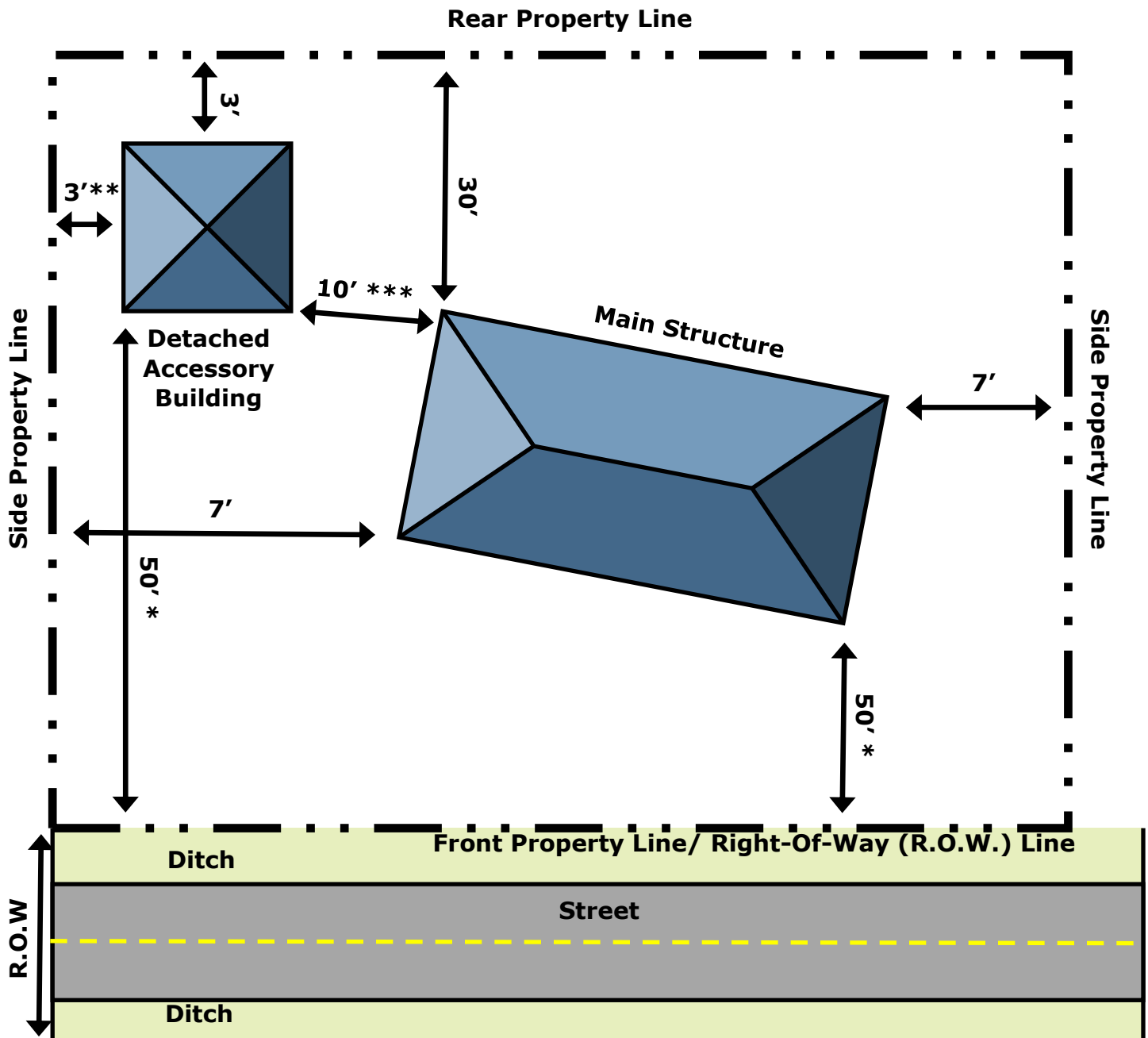

\* 30' front yard setback on subdivision roads

\*\* 3' set back applies only to buildings in the rear yard, otherwise 7' setback required

\*\*\* If set back less than 10,' accessory building is considered part of the main structure and a 7' side yard setback is required.

# MINIMUM SETBACK REQUIREMENTS

## Corner Lot in (A-1, RR, RC Zoning Districts)

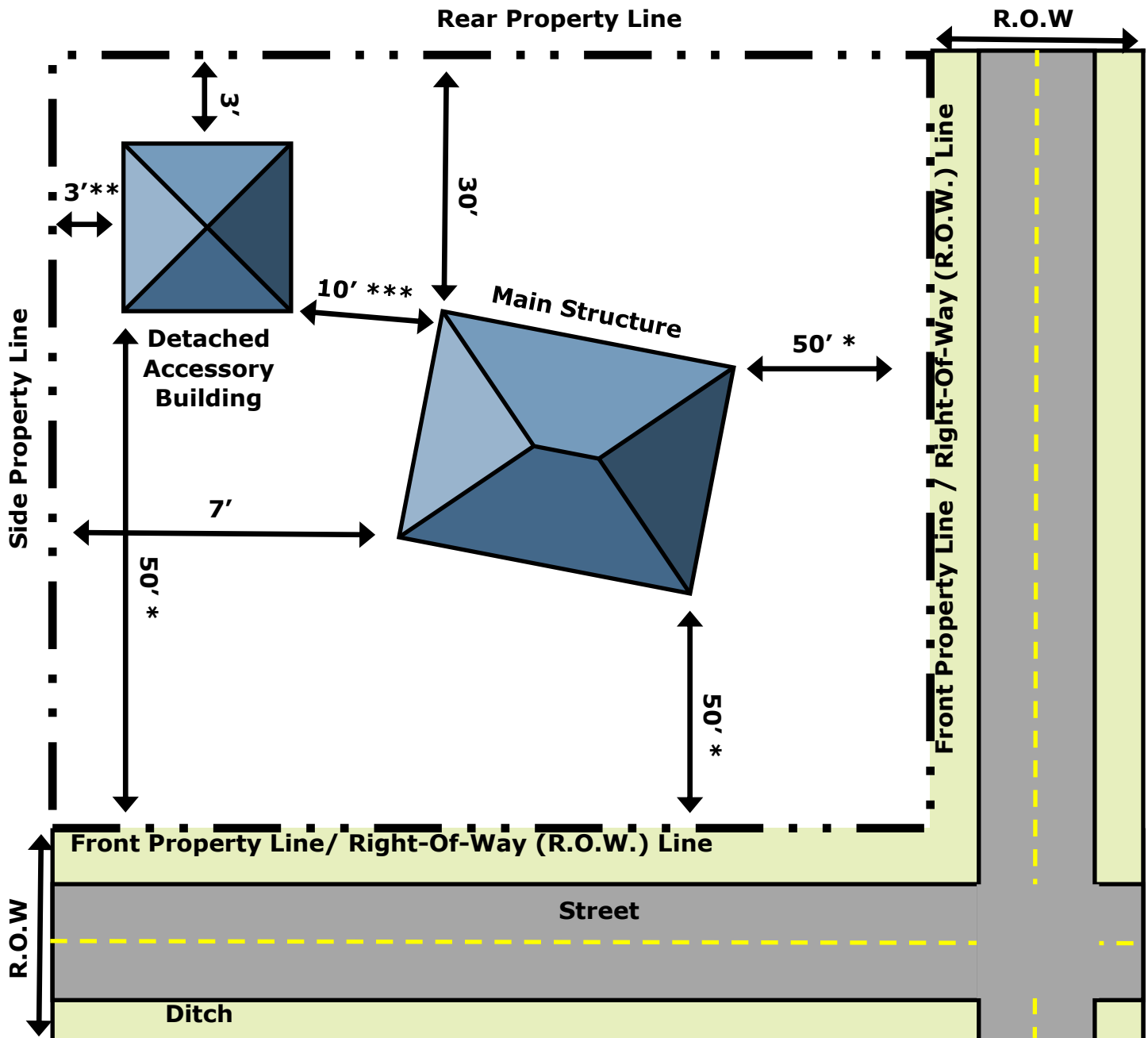

\* 30' front yard setback on subdivision roads

\*\* 3' set back applies only to buildings in the rear yard, otherwise 7' setback required

\*\*\* If set back less than 10,' accessory building is considered part of the main structure and a 7' side yard setback is required.



## RESIDENTIAL ACCESSORY BUILDINGS

An accessory building is defined within the zoning ordinance as: A subordinate building or portion of the main building, the use of which is incidental to and customary in connection with the main building or the main use of the premises and which is located on the same lot with such main building or use. An accessory use is on which is incidental to the main use of the premises.

### Accessory Building Size Regulations:

Accessory buildings located within a residential zoning district or within a subdivision of more than 4 lots are limited based on the size of the parcel as depicted in Table 4 below:

Table 4 Total Permissible Area of Accessory Buildings	
Size of Parcel	Total Permissible Area of Accessory Building Footprint
1.0 acres or less	1,600 Square Feet
1.1 to 3.0 acres	2,400 Square Feet
3.1 acres or more	3,600 Square Feet

A conditional use permit is required for accessory building requests larger than the permissible sized depicted in the table.

### Assumed Footing Diameters for Post Frame Structures:

Many accessory buildings are constructed as a post frame structure. The tables below list the required footings size for such structures as determined by the width of the structure.

Heated Non-Agriculture Footings			
Width (ft)	8' o.c. (in.)	9' o.c. (in.)	10' o.c. (in.)
30'	22"	23"	24"
40'	25"	26"	28"
50'	27"	29"	31"
60' *	30"	32"	33"
70' *	32"	34"	36"
80' *	34"	36"	38"

Unheated Non-Agriculture Footings			
Width (ft)	8' o.c. (in.)	9' o.c. (in.)	10' o.c. (in.)
30'	23"	25"	26"
40'	27"	28"	30"
50'	30"	31"	33"
60' *	32"	34"	36"
70' *	35"	37"	39"
80' *	37"	39"	41"

Notes: Static Values Assumed 2000 PSF, 2' O.H. 10 PSF Dead Load -  
 Footing size equals diameter by a minimum 12 inches thick.

\* Structures 60 feet wide or wider will require structural engineering for building and foundation for review prior to building permit

## DOORS

**Exit door required.** A minimum of one exit door is required for each dwelling unit. The required exit door shall provide for direct access from the living portion of the house to the outside. It cannot provide exit through a garage.

**Door type and size.** The exit door must be a side-hinged door. The door cannot be less than 3 feet in width and 6 feet, 8 inches in height. Other hinged or sliding doors do not have to meet these minimum dimensions.

**Type of lock or latch.** All egress doors must be readily openable from the inside. Opening the door can not require the use of a key or special knowledge or effort.

**Landings at doors.** There shall be a floor or landing on each side of each exterior door. The floor or landing at the exterior door cannot be more than 1.5 inches lower than the top of the threshold. The slope of the landing cannot exceed 0.25 unit vertical in 12 units horizontal ( 2 percent).

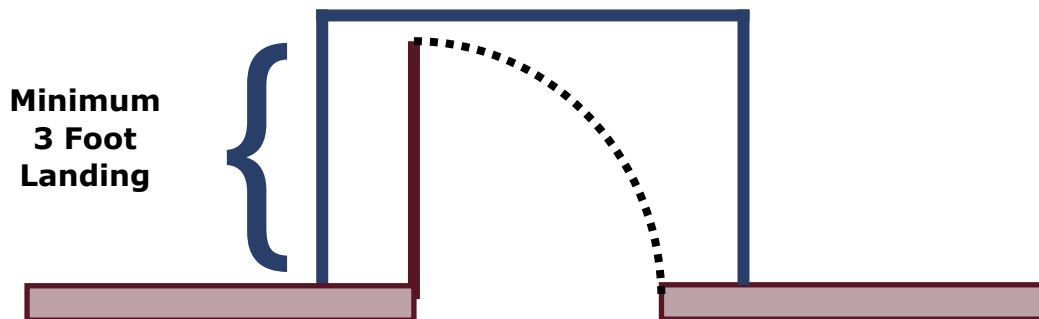

### Exceptions:

1. Where a stairway of two or fewer risers is located on the exterior side of a door, other than the required exit door, a landing is not required for the exterior side of the door provided the door, other than an exterior storm or screen door, does not swing over the stairway.
2. The exterior landing at an exterior doorway shall not be more than 8 inches below the top of the threshold, provided the door, other than an exterior storm or screen door, does not swing over the landing.
3. The height of floors at exterior doors other than the main exit door shall not be more than 8 inches lower than the top of the threshold.
4. The width of each landing shall not be less than the door served. Every landing shall have a minimum dimension of 36 inches measured in the direction of travel.

## EMERGENCY ESCAPE & RESCUE OPENINGS

**Emergency escape and rescue required.** Basements and every sleeping room shall have at least one openable emergency escape and rescue window or exterior door opening for emergency escape and rescue. Where basements contain one or more sleeping rooms, emergency egress and rescue openings shall be required in each sleeping room, but shall not be required in adjoining areas of the basement.. Emergency escape and rescue window openings with a finished sill height below the adjacent ground elevation shall be provided with a window well.

**Exception:** Storm Shelters and Basements used only to house mechanical equipment and not exceeding total floor area of 200 square feet

**Minimum opening area, height and width.** All emergency escape and rescue openings shall have a minimum net clear opening of 5.0 square feet (720 sq. in.).

The minimum net clear opening height shall be 24 inches.

The minimum net clear opening width shall be 20 inches.

The maximum sill height shall be 48" from the floor.

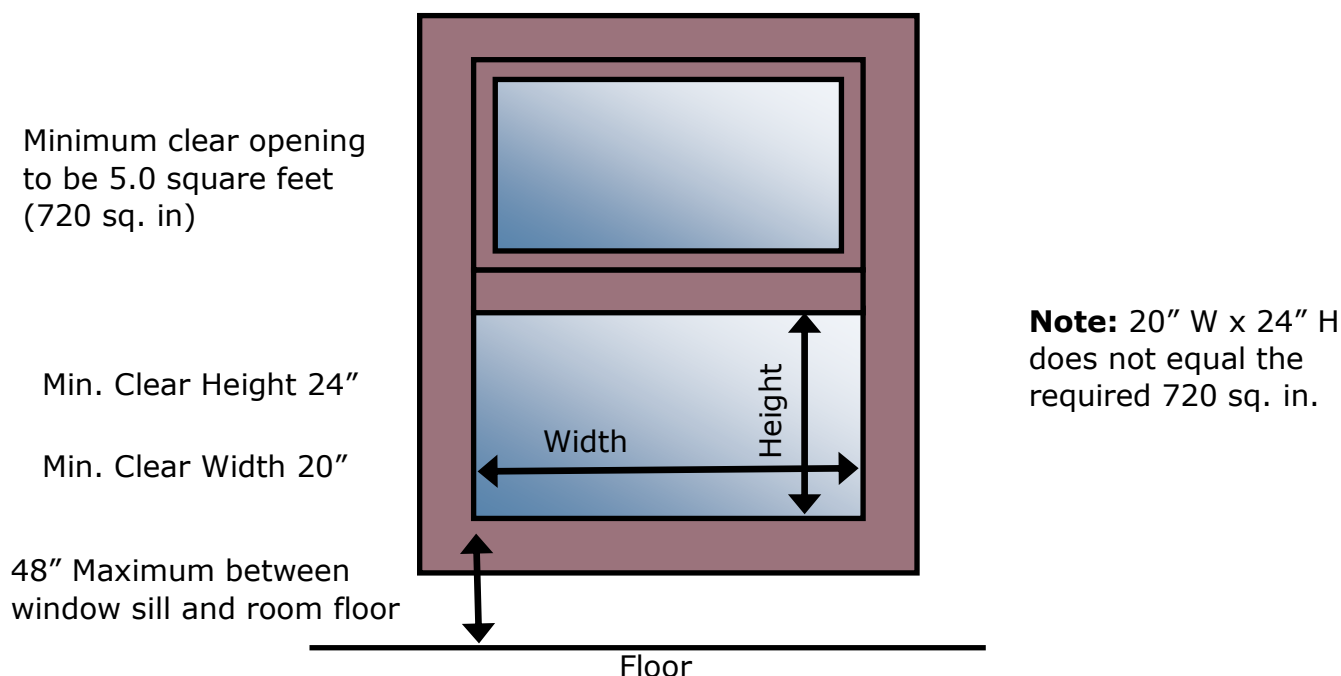

## EMERGENCY ESCAPE & RESCUE OPENINGS

Minimum Width/Height Requirements for Emergency Escape and Rescue Opening

Width	20	20.5	21	21.5	22	22.5	23	23.5	24	24.5	25
Height	36	35.1	34.2	33.5	32.7	32	31.3	30.6	30	29.4	28.8

Width	25.5	26	26.5	27	27.5	28	28.5	29	29.5	30
Height	28.6	27.7	27.2	26.6	26.1	25.7	25.3	24.8	24.4	24

**Operational constraints.** Emergency escape and rescue openings must be operational from the inside of the room without the use of keys, tools, or special knowledge.

**Window wells.** Window wells required for emergency escape and rescue must allow the door or window of the emergency escape and rescue opening to be fully opened. The horizontal dimensions of the window well must provide a minimum net clear area of 9 square feet with a minimum horizontal projection and width of 36 inches.

**Ladder and steps.** Window wells with a vertical depth greater than 48 inches below the adjacent ground level must be equipped with a permanently affixed ladder or steps usable with the window in the fully open position. Ladders or rungs shall have an inside width of at least 12 inches, must project at least 3 inches from the wall and must be spaced not more than 18 inches on center vertically for the full height of the window well.

**Bars, grills, covers and screens.** Bars, grills, covers, screens, or similar devices are permitted to be placed over emergency escape and rescue openings, bulkhead enclosures, or window wells that serve such openings, provided the minimum net clear opening size complies, and such devices must be releasable or removable from the inside without the use of a key, tool, special knowledge or force greater than that which is required for normal operation of the escape and rescue opening.

**Emergency escape windows under decks and porches.** Emergency escape windows are allowed to be installed under decks and porches provided the location of the deck allows the emergency escape window to be fully opened and provides a path not less than 36 inches (914 mm) in height to a yard or court.

## WINDOW GLAZING

**Identification.** Each pane of glazing installed in hazardous locations shall be provided with a manufacturer’s designation specifying who applied the designation, designating the type of glass and the safety glazing standard with which it complies, which is visible in the final installation. The designation shall be acid etched, sandblasted, ceramic fired, laser etched, embossed or be of a type which once applied cannot be removed without being destroyed.

### Hazardous locations:

1) *Glazing in doors.* Glazed in all fixed and operable panels of swinging, sliding and bifold doors.

2) *Glazing adjacent to doors.* Glazing in an individual fixed or operable panel adjacent to a door shall be considered to be a hazardous location where the bottom exposed edge of the glazing is less than 60 inches above the floor or walking surface and it meets either of the following conditions:

1.1 Where the glazing is within 24 inches of either side of the door in the plane of the door in a closed position.

1.2 Where the glazing is on a wall perpendicular to the plane of the door in a closed position and within 24 inches of the hinge side of an in-swinging door.

3) *Glazing in windows.* Glazing in an individual fixed or operable panel that meets all of the following conditions:

3.1 The exposed area of an individual pane is larger than 9 square feet, and

3.2 The bottom edge of the glazing is less than 18 inches above the floor, and

3.3 The top edge of the glazing is more than 36 inches above the floor, and

3.4 One or more walking surfaces are within 36 inches, measured horizontally and in a straight line, of the glazing.

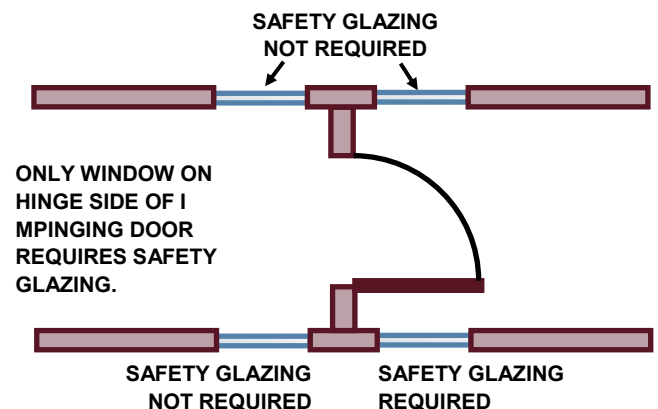
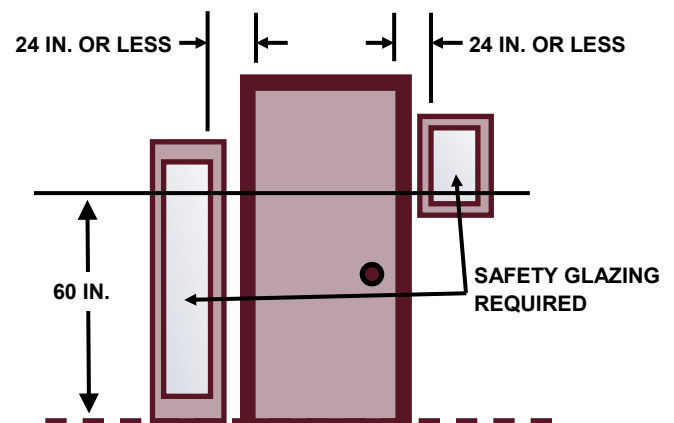

**Hazardous Location for Glazing Adjacent to a Door**

## WINDOW GLAZING

- 4) *Glazing in guards and railings.* Glazing in guards and railings, including structural baluster panels and nonstructural in-fill panels, regardless of area or height above a walking surface, shall be considered to be a hazardous location.
- 5) *Glazing and wet surfaces.* Glazing in walls, enclosures, or fences containing or facing hot tubs, spas, whirlpools, saunas, steam rooms, bathtubs, showers, and indoor or outdoor swimming pools where the bottom exposed edge of the glazing is less than 60 inches measured vertically above any standing or walking surface shall be considered to be a hazardous location. This shall apply to single glazing and each pane in multiple glazing.
- 6) *Glazing adjacent to stairs and ramps.* Glazing where the bottom exposed edge of the glazing is less than 36 inches above the plane of the adjacent walking surface of stairways, landings between flights of stairs, and ramps shall be considered to be a hazardous location.
- 7) *Glazing adjacent to the bottom stair landing.* Glazing adjacent to the landing at the bottom of a stairway where the glazing is less than 36 inches above the landing and within a 60-inch horizontal arc less than 180 degrees from the bottom tread nosing shall be considered to be a hazardous location.

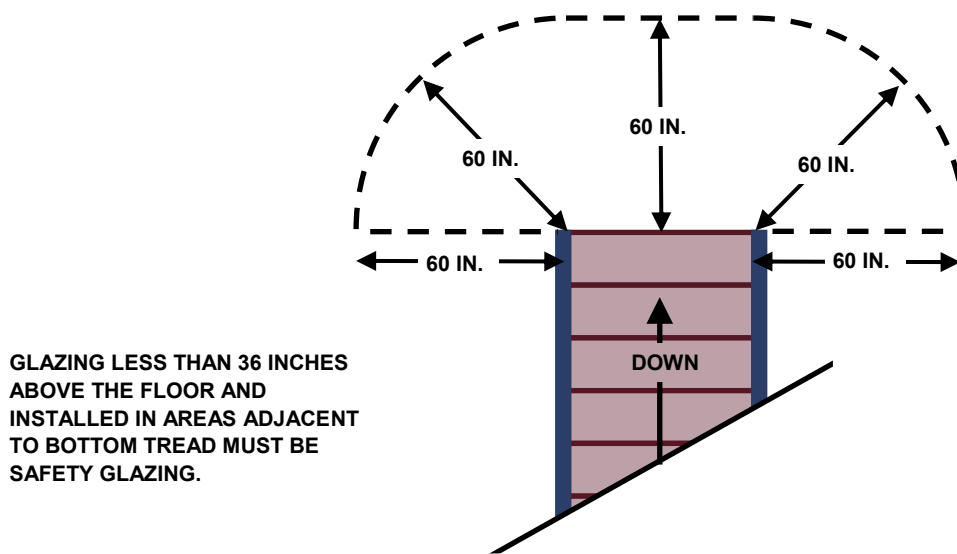

**Safety Glazing at Bottom Stair Landings**

## GARAGES

**Opening protection.** A garage may not open into a room used for sleeping purposes. Openings between the garage and residence must have solid wood doors of not less than 1-3/8 inch in thickness, solid or honeycomb core steel doors not less than 1-3/8 inches thick, or 20-minute fire-rated doors.

**Duct penetration.** Ducts in the garage and ducts penetrating the walls or ceilings separating the dwelling from the garage must be constructed of a minimum No. 26 gage sheet steel or other approved material and have no openings into the garage.

**Other penetrations.** Penetrations through the required garage separation must be protected by filling the opening around the penetrating item with approved material to resist the free passage of flame and products of combustion.

**Separation required.** The garage must be separated from the residence and its attic area by not less than 1/2 inch gypsum board applied to the garage side. Garages beneath habitable rooms must be separated from the rooms above by not less than 5/8-inch Type X gypsum wallboard or equivalent. Type X gypsum board must be installed perpendicular to the ceiling framing and fastened at maximum 6 inch o.c. by minimum 1-7/8 inch 6d coated nails or equivalent drywall screws and shall have the joints taped. Where the separation is a floor- or a roof-ceiling assembly, the structure supporting the separation must also be protected by not less than 1/2 inch gypsum board or equivalent.

Garages located less than 3 feet from a dwelling unit on the same lot must be protected with not less than 1/2-inch gypsum board applied to the interior side of exterior walls that are within this area. This provision does not apply to garage walls that are perpendicular to the adjacent dwelling unit wall.

**Floor surface.** Garage floor surfaces must be of approved noncombustible material. The area of floor used for parking of automobiles or other vehicles shall be sloped to facilitate the movement of liquids to a drain or toward the main vehicle entry doorway.

## SWIMMING POOLS, HOT TUBS, & SPAS

**Requirements.** Every outdoor swimming pool, including an in-ground, above-ground or on-ground pool, hot tub or spa must have a barrier which complies with the following guidelines. The barrier must be installed, inspected and approved prior to filling with water.

The top of the barrier shall be at least 42 inches (1,067 mm) above grade measured on the side of the barrier which faces away from the swimming pool. The maximum vertical clearance between grade and the bottom of the barrier shall be 2 inches (51 mm) measured on the side of the barrier which faces away from the swimming pool. Where the top of the pool structure is above grade, such as an aboveground pool, the barrier may be at ground level, such as the pool structure, or mounted on top of the pool structure. Where the barrier is mounted on top of the pool structure, the maximum vertical clearance between the top of the pool structure and the bottom of the barrier shall be 4 inches (102 mm).

Openings in the barrier shall not allow passage of a 4-inch-diameter (102 mm) sphere.

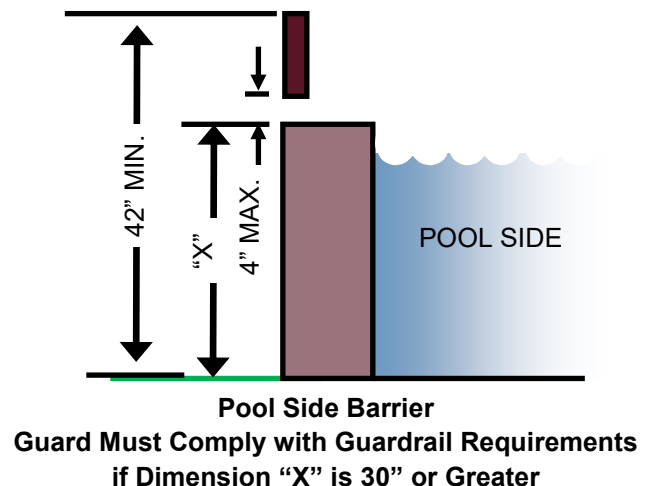
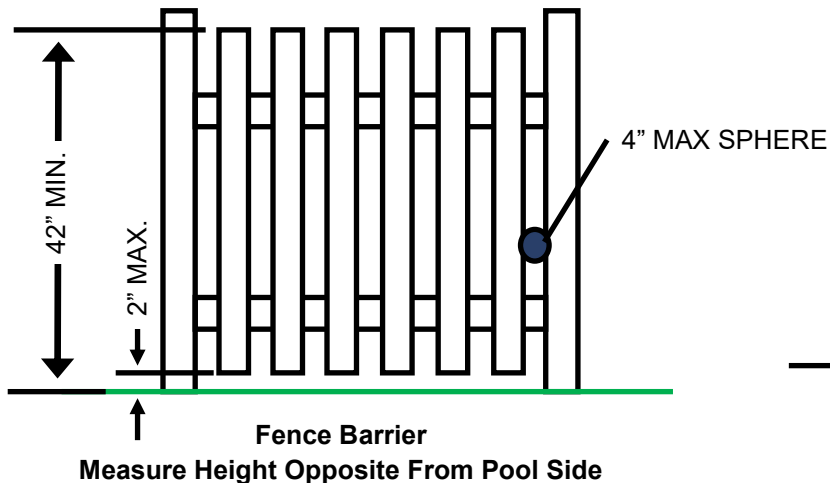



## SWIMMING POOLS, HOT TUBS, & SPAS

Where an aboveground pool structure is used as a barrier or where the barrier is mounted on top of the pool structure, and the means of access is a ladder or steps, then the ladder or steps shall be capable of being secured, locked or removed to prevent access, or the ladder or steps shall be surrounded by a barrier. When the ladder or steps are secured, locked or removed, any opening created shall not allow the passage of a four inch-diameter (102 mm) sphere.

All gates or door openings through the barrier shall be equipped with self-closing and self-latching devices for keeping the door or gate securely closed at all times when the pool is not in actual use, except that the door of any dwelling that form part of the enclosure need not be so equipped.

**Exception:** A property which meets all of the following standards and has an outdoor swimming pool shall be exempt from the above referenced barrier requirements.

- The property is not within a residential zoning district.
- The property is not located within a platted subdivision of five or more lots.
- The swimming pool is greater than 500 feet from any dwelling other than a dwelling located on the same property.

Modifications in individual cases, upon a showing of good cause with respect to height, nature, or location of a fence, wall, gates, or latches, or the necessity thereof, may be made by the building official, provided the protection as sought hereunder is not reduced thereby. The building official may grant permission for other protective devices or structures to be used as long as the degree of protection afforded by this substitute device or structure is not less than the protection afforded by the wall, fence, gate, and latch described herein. A reasonable period within which to comply with the requirements of this section for existing swimming pools shall be allowed, which period shall not exceed 90 days after notification by the building official.

## SWIMMING POOLS, HOT TUBS, & SPAS

### Entrapment Protection

**General.** Suction outlets shall be designed to produce circulation throughout the pool or spa. Single outlet systems, such as automatic vacuum cleaner systems, or other such multiple suction outlets whether isolated by valves or otherwise shall be protected against user entrapment.

**Suction fittings.** Except for surface skimmers, all Pool and Spa suction outlets shall be provided with a cover that conforms with ANSI/ASME A112.19 or a 12"x12' drain grate or larger, or an approved channel drain system.

**Atmospheric vacuum relief system required.** All pool and spa single or multiple outlet circulation systems shall be equipped with atmospheric vacuum relief should grate covers located therein become missing or broken. Such vacuum relief systems shall include at least one approved or engineered method of the type specified herein, as follows:

1. Safety vacuum release system conforming to AS A1 12.19.17, or
2. An approved gravity drainage system.

**Dual drain separation.** Single or multiple pump circulation systems shall be provided with a minimum of two (2) suction outlets of the approved type, a minimum horizontal or vertical distance of three (3) feet shall separate such outlets. These suction outlets shall be piped so that water is drawn through them simultaneously through a vacuum relief-protected line to the pump or pumps.

**Pool cleaner fittings.** Where provided, vacuum or pressure cleaner fitting(s) shall be located in an accessible position(s) at least six (6) inches and not greater than twelve (12) inches below the minimum operational water level or as an attachment to the skimmer(s).

## SECURITY

**Doors.** Exterior dwelling doors and doors between the house and garage shall be provided with hardware such that an individual cannot gain entry from the exterior by pushing or pulling, or by manipulating an exposed lock mechanism.

**Strike plate installation.** In wood frame construction, an open space between trimmers and wood doorjamb shall be solid shimmed by a single piece extending not less than 12 inches above and below the strike plate. Strike plates shall be attached to wood with not less than four No. 8 by 3-inch screws, which shall have a minimum of 3/4-inch penetration into the nearest stud. Strike plates, when attached to metal, shall be attached with not less than four No. 8 machine screws.

**Hinges.** When hinges are exposed to the exterior, at least one of the three required hinges shall be equipped with non-removable hinge pins or a mechanical interlock to preclude removal of the door from the exterior by removing the hinge pins. Not less than three 4 1/2-inch steel butt hinges shall be symmetrically fastened to both the door and frame with not less than four No. 9 by 3/4-inch wood screws or to metal with not less than four No. 8 machine screws. In wood construction, an open space between trimmers and wood doorjamb shall be solid shimmed extending not less than 6 inches above and below the plate.

**Locking hardware.** Single-swinging doors and the active leaf of doors in pairs, shall be equipped with an approved exterior key-operated deadbolt. The deadbolt shall have a minimum one-inch throw and must be actuated by a key from the exterior and a knob or thumb turn on the interior. When projected, the deadbolt shall become locked against return by end pressure. Sliding doors must be provided with a locking mechanism activated from the interior.

**Windows.** Window assemblies defined as units composed as a group of parts that closes an opening in a wall to control light, air, and other elements shall be provided with a latching device activated from the interior, which is intended to resist opening a movable sash from the exterior.

**Entry vision.** All main and front entry doors to dwelling units shall be arranged so that the occupant has a view of the area immediately outside the door without opening the door. Such view may be provided by a door viewer having a field of view of not less than 180 degrees through windows or through view ports.

## SMOKE ALARMS/CARBON MONOXIDE ALARMS

Smoke Alarms are required in each sleeping room and centrally located outside each separate sleeping area. Smoke alarms are required on each story including the basement.

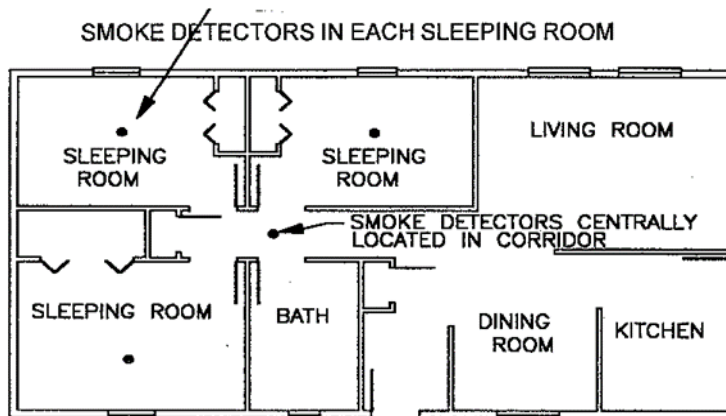

### Slit Level Construction

In dwellings or dwelling units with split levels and without an intervening door between the adjacent levels, a smoke alarm installed on the upper level shall suffice for the adjacent lower level provided that the lower level is less than one full story below the upper level.

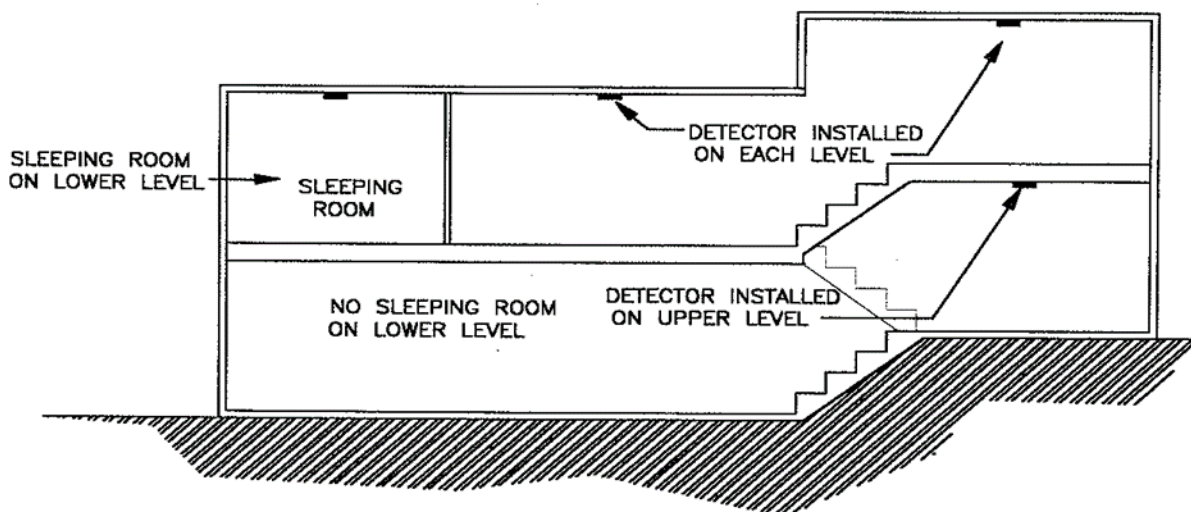

## SMOKE ALARMS/CARBON MONOXIDE ALARMS

Where the ceiling height of a room is open to the hallway serving a bedroom exceeds that of the hallway by 24 inches (610 mm) or more, smoke detectors shall be installed in the hallway and in the adjacent room. Hallways less than 4 feet (1,220 mm) in length are allowed to omit the smoke detector within the hallway adjacent to the bedrooms where the smoke detector is installed in the adjacent room with the higher ceiling.

When more than one smoke alarm is required to be installed within an individual dwelling unit, the alarm devices shall be interconnected in such a manner that the actuation of one alarm will activate all of the alarms in the individual unit.

**Alterations, repairs, and additions.** When alterations, repairs, or additions requiring a permit occur with a valuation in excess of \$1,000, or when one or more sleeping rooms are added or created in existing dwellings, the individual dwelling unit shall be equipped with smoke alarms located as required for new dwellings.

**Exception:** Work involving the exterior surfaces of dwellings, such as the replacement of roofing or siding, or the addition or replacement of windows or doors, or the addition of a porch or deck, are exempt from the requirements of this section.

**Power source.** In new construction, the required smoke alarms shall receive their primary power from the building wiring when such wiring is served from a commercial source, and when primary power is interrupted, shall receive power from a battery. Wiring shall be permanent and without a disconnecting switch other than those required for overcurrent protection. Smoke alarms shall be permitted to be battery operated when installed in buildings without commercial power or in buildings that undergo alterations, repairs, or additions.

### CARBON MONOXIDE ALARMS

**Carbon Monoxide Alarms.** For new construction, an approved carbon monoxide alarm shall be installed outside of each separate sleeping area in the immediate vicinity of the bedrooms in the dwelling units within which fuel-fired appliances are installed and in dwelling units that have attached garages.

**\*\*Alarm requirements:** Single station carbon monoxide alarms shall be listed as complying with UL2034 and shall be installed in accordance with this code and the manufacturer's installation instructions. They may be combined with the smoke detector.

## STAIRWAYS

**Width.** Stairways shall not be less than 36 inches in clear width at all points above the permitted handrail height and below the required headroom height. The width of spiral stairways shall be in accordance with spiral stairway provisions. Handrails shall not project more than 4.5 inches on either side of the stairway and the minimum clear width of the stairway at and below the handrail height, including treads and landings, shall not be less than 31.5 inches where a handrail is installed on one side and 27 inches where handrails are provided on both sides.

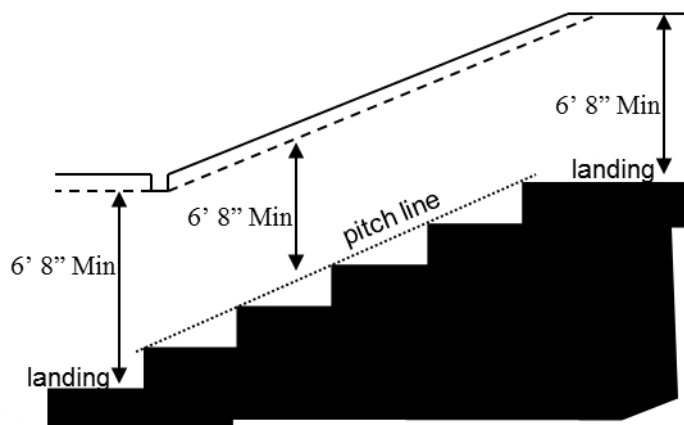
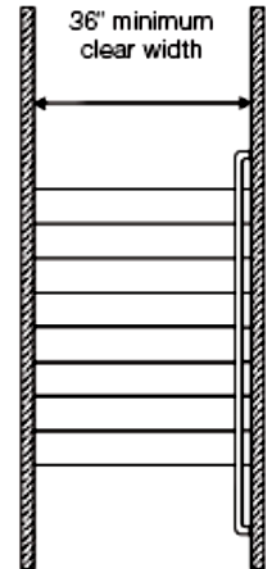

**Headroom.** The minimum headroom in all parts of the stairway shall not be less than 6 feet 8 inches measured vertically from the sloped plan adjoining the tread nosing (pitch line) or from the floor surface of the landing or platform.

**Riser Height and Tread Depth.** The maximum riser height shall be 8 inches, measured vertically between the leading edges of the adjacent treads. Open risers are permitted. The minimum tread depth shall be 10 inches, measured horizontally between the vertical planes of the foremost projection of the adjacent treads and at a right angle to the tread's leading edge.

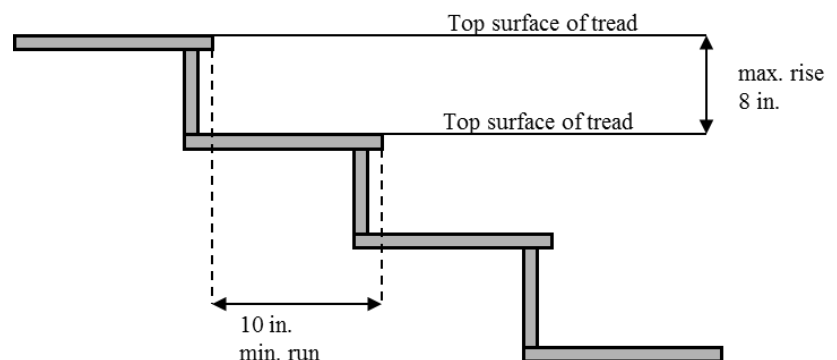

## STAIRWAYS

**Riser and Tread Continuity.** The greatest riser height within any flight of stairs shall not exceed the smallest by more than  $\frac{3}{8}$  inch.

**Spiral Stairways.** Spiral stairways are permitted, provided that the clear width at and below the handrail is not less than 26 inches and the walkline radius is not greater than  $24\frac{1}{2}$  inches. Each tread shall have a depth of not less than  $6\frac{3}{4}$  inches at the walkline. All treads shall be identical, and the rise shall not be more than  $9\frac{1}{2}$  inches. Headroom shall be not less than 6 feet 6 inches.

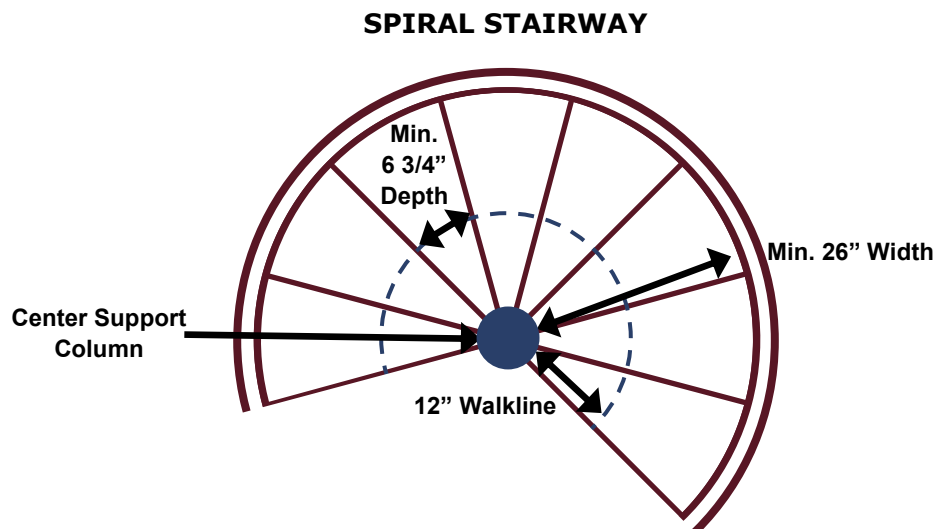

## STAIRWAYS

**Winders and Circular Stairs.** Winders are permitted. The width of the tread at a point not more than 12 inches from the side where the treads are narrower is not less than 10 inches and the minimum width of any tread is not less than 6 inches. The tread depth of a circular stair at any walking line shall be uniform, measured at a consistent distance from a side of the stairway.

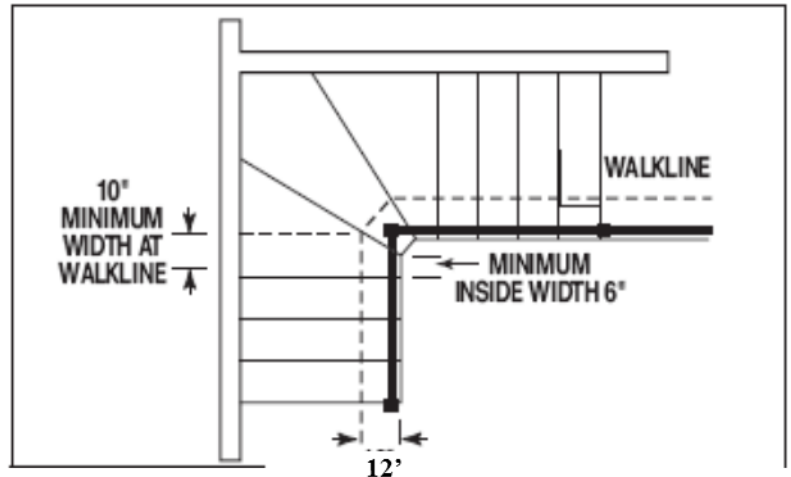

### ALTERNATE WINDER DESIGNS

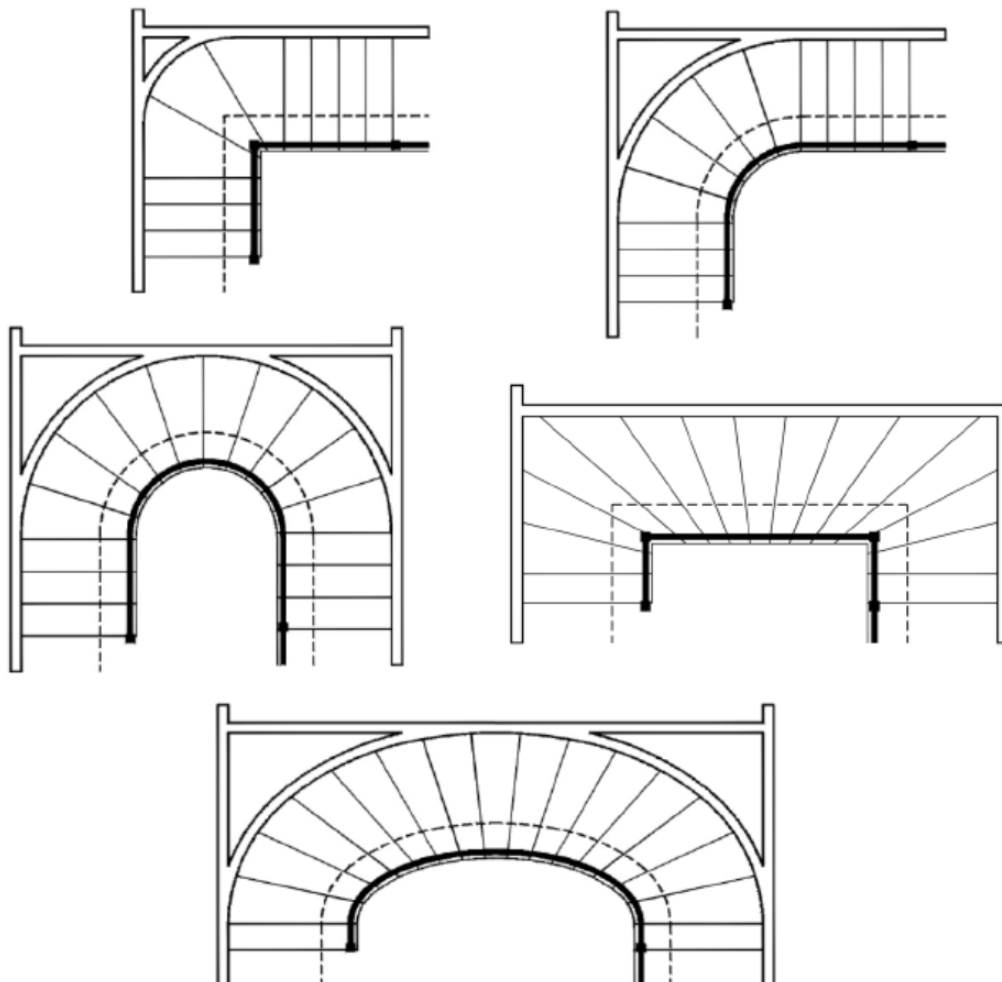



## STAIRWAYS/HANDRAILS

**Landings for stairways.** There shall be a floor or landing at the top and bottom of each stairway. The width of each landing shall not be less than the width of the stairway served. Every landing shall have a minimum dimension of 36 inches measured in the direction of travel.

**Exception:** A floor or landing is not required at the top an interior flight of stairs, including stairs in an enclosed garage, provided a door does not swing over the stairs.

A flight of stairs shall not have a vertical rise larger than 147 inches between floor levels or landings.

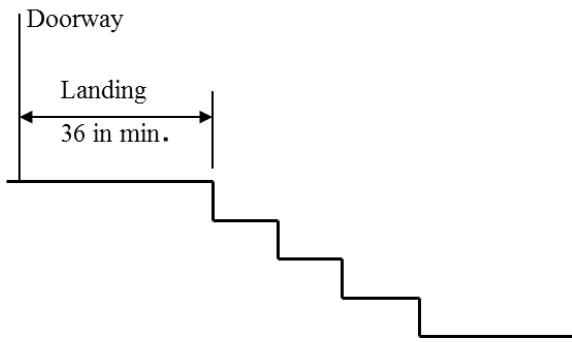

**Stairway walking surface.** The walking surface of treads and lands of stairways shall be sloped no steeper than one unit vertical in 48 inches horizontal (2 percent slope).

**Under stair protection.** Enclosed accessible space under stairs shall have walls, under stair surface and any soffits protected on the enclosed side with ½ inch gypsum board.

**Number of handrails** - Handrails shall be provided on at least one side of each continuous flight with four or more risers. (This rule also applies to exterior stairs.)

On ramps, a handrail is required on at least one side if the ramp slope exceeds 1 unit vertical to 12 units horizontal (8.33 percent slope).

**Height** - Handrails shall be mounted so that the top of the handrail is between 34 and 38 inches above the stair tread at the nosing.

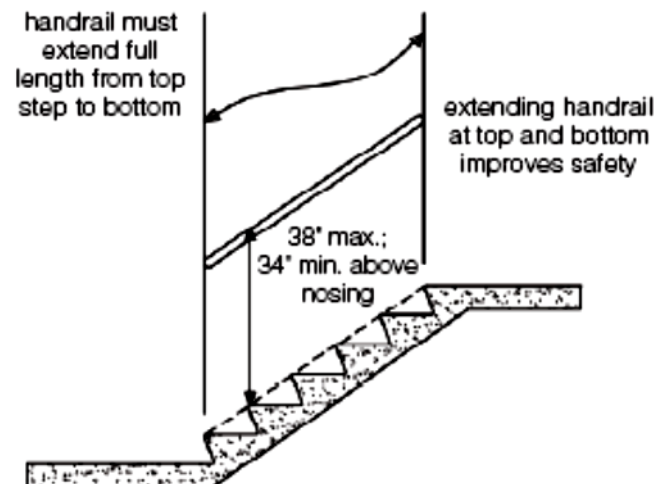

## HANDRAILS

**Continuity** - Handrails shall be continuous the full length of the flight or ramp. They cannot be interrupted by newel posts, except at a turn. They shall start at least directly above the top riser, and extend to at least the top of the lowest riser. The ends of the handrails must either be “returned,” or end in safety terminals. (A “return,” for example, is where the end of the handrail turns into the adjacent wall.) At the lowest tread, a newel post, volute, turnout or starting easing is permitted in the handrail.

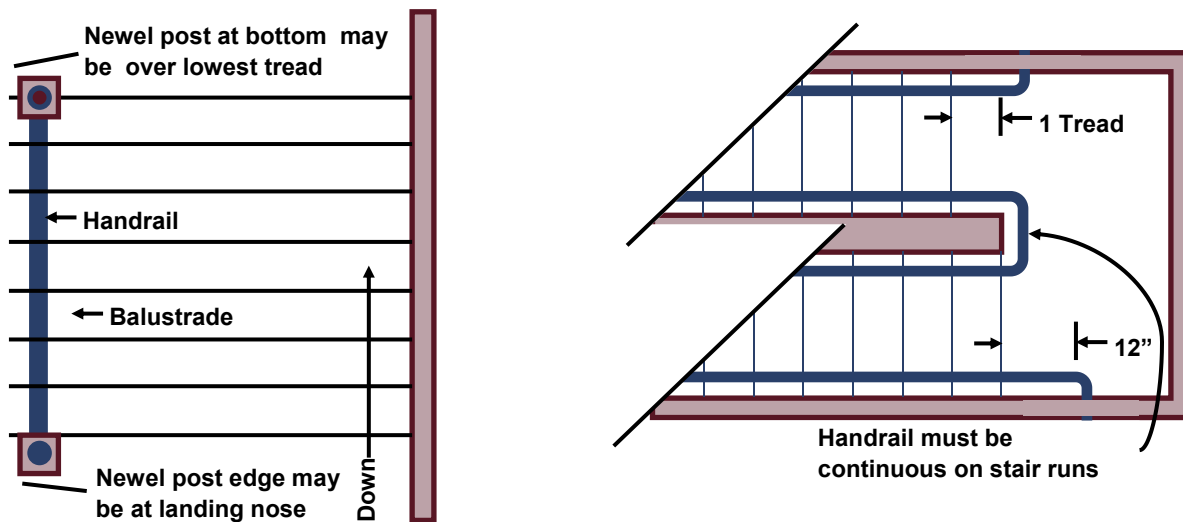

**Handrail grip size** - A handrail that is round in cross section must be between 1¼ to 2 inches in diameter. If a handrail is not round, it must provide an equivalent surface that is easily grasped. There are two alternate types:

- Handrails with a perimeter dimension between 4 and 6¼ inches, with a maximum cross section of 2¼ inches.
- Handrails with a perimeter dimension greater than 6¼ inches must have a graspable finger recess area.

**Clearance** - The handrail must also be far enough away from the wall so it can be easily grasped. The minimum clear distance is 1½ inches between the handrail and the wall.

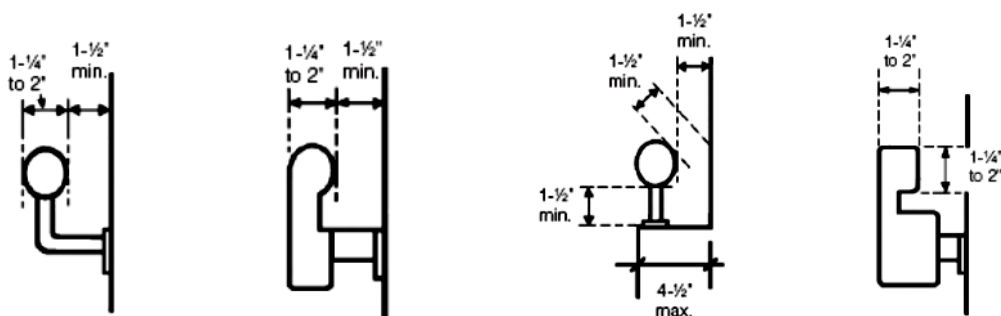

## RAMPS

**Maximum Slope.** When planning a ramp, first measure from the ground to the base of the doorway to find out how much elevation is needed. The ramp shall not have a gradient greater than 1 in 12. Therefore, for every inch of rise, the ramp requires 12 inches of run (8.33% slope). Where it is technically infeasible to comply because of site constraints, for every one inch of rise, ramps may have 8 inches of run. (12.5 % slope).

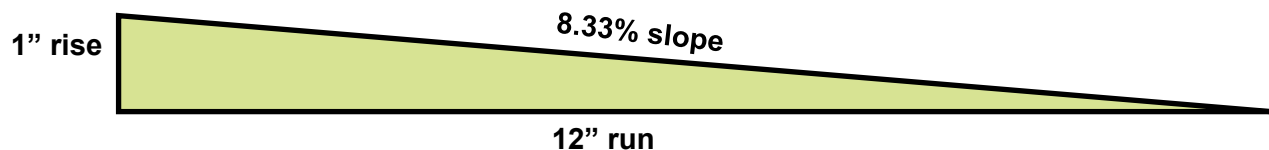

**Landings required.** A minimum 3 ft. X 3 ft. landing shall be provided at the top, at the foot, and where doors open onto ramps. Ramps are allowed to change directions, provided that level landings are installed.

**Handrails required.** Ramps which have a gradient greater than 8.33% or 1:12 or one ft. rise in 12 ft. of run shall have handrails on at least one side of the ramp. Handrails shall be mounted so that the top of the handrail is located between 34 and 38 inches above the finished surface of the ramp. Hand rail grip size shall be consistent with stairway requirements. The clear space between the handrail and any adjoining wall shall be a minimum of 1.5 inches. Handrails shall be continuous for the full length of the ramp and handrail ends shall be returned or end in newel posts or safety terminals.

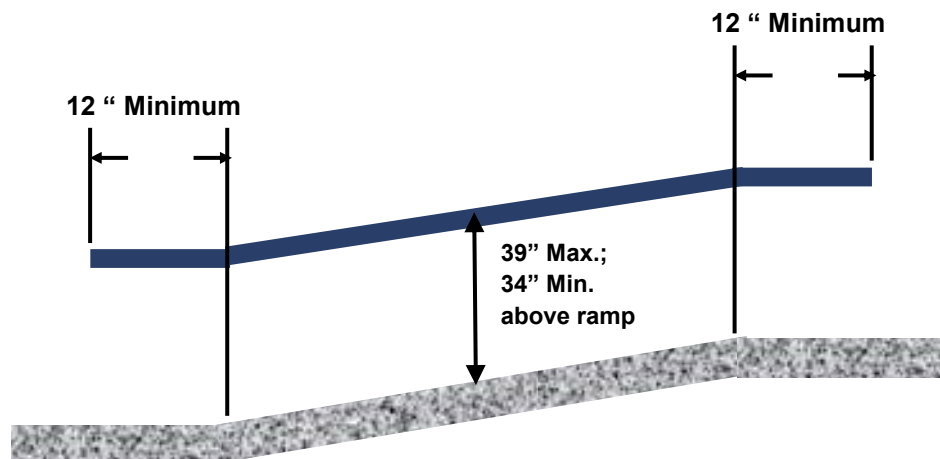

## GUARDS

Guards are required for porches, balconies, ramps or raised floor surfaces which are located more than 30 inches above the floor or grade below. The guards shall be a minimum 36 inches in height. If a fixed bench is installed, the 36" guard will be measured vertically from the bench seat level.

Open sides of stairs with a total rise of more than 30 inches above the floor or grade below, shall have guards not less than 34 inches in height when measured vertically from the nosing of the treads.

Guards are required on porches and decks which are enclosed with insect screening where the walking surface is located more than 30 inches above the floor or grade below.

Guard in-fill components (except the handrail), balusters, and panel fillers shall be designed to withstand a horizontally applied normal load of 50 pounds on an area equal to 1 square foot.

Opening limitations. Where guards are required on open sides of stairways, raised floor areas, balconies, and porches, intermediate rails or ornamental closures are required which are close enough together so that a sphere of 5 inches or more in diameter will not pass through. On an open stairway, in the triangular space formed by the riser, tread, and bottom rail of the guard a sphere of 6 inches shall not pass through.

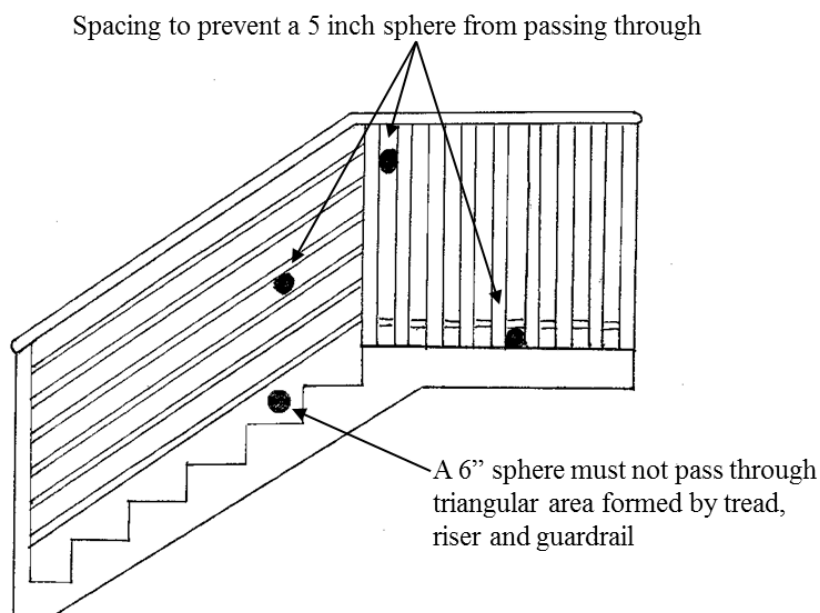

## SNOW LOADS

- Roofs must be designed for a minimum ground snow load of 40 pounds per square foot. In no case shall the live load be less than the following:
- Roof slopes of 3/12 or less shall carry a snow load of 30 pounds per square foot.
- Roof slopes of 3/12 or greater shall carry a snow load of 25 pounds per square foot.
- Roof slopes of 1/4 per 12 inches shall be designed to carry an additional 5 pounds per square foot in addition to the live load due to snow.

## CLIMATIC AND GEOGRAPHIC DESIGN CRITERIA

1. **Ground Snow Load.** 40 psf Ground Snow Load for engineered designs.  
On roof systems that are not engineered, conventionally framed roof slopes with a rise of 3 inches or less to 12 inches shall be designed for a full or unbalanced snow load of not less than 30 pounds per square foot of horizontal projection.  
Where a roof system is designed to slope less than 1/4 inch per 12 inches, a surcharge load of not less than 5 pounds per square foot in addition to the required live load due to snow shall be designed into the roof system.  
Roof slopes with over 3 inches of rise per 12 inches shall be designed for a full or unbalanced Snow load of not less than 25 pounds per square foot of horizontal projection.  
Potential unbalanced accumulation of snow at valleys, parapets, roof structures, and offsets in roofs of uneven configuration shall be considered.
2. **Wind Speed.** 115 mph. When an engineered design is deemed necessary, the wind exposure category shall be determined on a site specific basis.
3. **Seismic Design Category.** Seismic Zone A.
4. **Weathering.** Severe. Weathering may require a higher strength concrete or grade of masonry than necessary to satisfy the structural requirements of the code.
5. **Frost Line Depth.** 42 inches minimum.
6. **Termite Damage.** Slight to moderate.
7. **Winter Design Temperature.** -11 degrees Fahrenheit.
8. **Ice Barrier Underlayment Requirement.** Yes.
9. **Flood Hazards.** 2017 Revised Floodplain Ordinance for Minnehaha County.
10. **Mean Annual Temperature.** 46 degrees Fahrenheit.

## BARRIER-FREE ACCESSIBILITY

**Background.** The Americans with Disabilities Act and the Federal Fair Housing Act recognize the importance of providing access to buildings and other facilities for people with mobility, sensory and other disabilities.

**Accessibility Regulations.** Minnehaha County has adopted the requirements for barrier-free accessibility that are found in Chapter 11 of the International Building Code (IBC). It is the contractor and property owner's responsibility to comply with all the requirements of Chapter 11.

**Federal Regulations.** In addition to the Building Code regulations, there are two sets of federal regulations that govern accessibility.

- The Americans with Disabilities Act (ADA) and the Americans with Disabilities Act Accessibility Guidelines (ADAAG) apply to non-residential buildings.
- The Fair Housing Act (FHA) and related guidelines apply to residential buildings.

These federal regulations are not enforced by the Planning Department; compliance is entirely the responsibility of the owner and contractor. Both sets of regulations are civil rights protections that can be enforced by lawsuits brought by private citizens. Approval of a building by the Planning Department does not guarantee compliance with the federal regulations.

### Additional Information:

- Prairie Freedom Center for Independent Living, (605) 367-5630 or (800) 947-3770; 301 S. Garfield Ave. Suite 8 Sioux Falls.
- ADA Information Line at the U.S. Department of Justice, (800) 514-0301 (voice); (800) 514-0383 (TTY); [www.ada.gov](http://www.ada.gov)
- The Department of Justice website at [www.usdoj.gov/crt/ada/publicat.htm](http://www.usdoj.gov/crt/ada/publicat.htm) contains the text of the regulations and other informational publications.
- The text of ADAAG and other technical assistance is found at [www.access-board.gov](http://www.access-board.gov).
- FHA Accessibility guidelines and other information is found at [www.hud.gov/groups/fairhousing.cfm](http://www.hud.gov/groups/fairhousing.cfm).
- Sioux Falls HUD office (605) 220-5101 (voice); (605) 330-4426 (TTY); 2400 W. 49th St. Suite I-201

## COMMON RESIDENTIAL CODE REQUIREMENTS

This section outlines pertinent code items required for residential projects. Additional items may be required depending on the specific project. Remember that these guidelines are not substitutes for codes and regulations. You are responsible for ensuring that your project complies with the specific requirements of all relevant codes and regulations as adopted by Minnehaha County.

- 2021 International Building Code (IBC) as adopted by Minnehaha County
- 2021 International Residential Building Code (IRC) as adopted by Minnehaha County
- 2021 International Existing Building Code (IEBC) as adopted by Minnehaha County

### 1. **Building Plans.** Residential building plans should include the following:

- Site Plan
- Foundation Plan
- Floor Plans, including labeled use of all rooms
- Roof and floor framing plans including existing framing affected by additions or alterations

### 2. **Building Separation Requirements.** Proximity to property line-

- 1-hour wall is required if less than 5' to property line.
- No openings (doors and windows) in walls less than 3' to property line.
- Eaves closer than 4' to property line must be finished on the underside with at least 1/2" gypsum sheathing or equivalent.

### 3. **Garage/Dwelling Separation Requirements.**

- 1/2" regular gypsum board required on garage side walls between garage and dwelling.
- Garage ceilings where dwelling above requires 5/8" type "X" gypsum board. Supporting structure requires 1/2" regular gypsum board.
- 1-3/8" thick (Min.) solid core (solid wood, solid or honey comb steel) or 20 minute fire rated door required between garage and dwelling.
- No separation required at carports (2 sides open).

Continued on next page.

## COMMON RESIDENTIAL CODE REQUIREMENTS

### 4. Life Safety Requirements. Stairs

- Minimum width = 36"
- Maximum 8" rise
- Minimum 10" run
- Minimum 6'8" head room
- Handrail 34"-38" above tread nosing
- Handrail grasping dimension 1-1/4" minimum – 2" maximum
- For winding stairs provide a minimum 10" tread at 12" from the narrowest point and a minimum 6" tread at the narrowest point.

### 5. Decks/Guardrails

- Guard (guardrail) required for walking surfaces 30" above adjacent grade or floor below.
- 36" high required minimum
- 5" maximum clear space between intermediate rails

### 6. Smoke Alarms/Carbon Dioxide Detectors

- Smoke detectors required when permit required, or when one or more bedrooms added.
- Must be powered by interconnected building wiring, and have battery back-up in new construction and additions.
- May be battery-powered in alterations except when wiring can be installed without removal of interior finishes.
- Required in sleeping rooms, outside sleeping areas, and other floors (including basements). Any alarm must be clearly audible in all bedrooms.
- Battery-powered okay in existing buildings not being remodeled.

### 7. Emergency Escape and Rescue

Basements and every sleeping room must meet these requirements:

- 5' minimum net clear open area
- 20" minimum clear open width
- 24" minimum clear open height
- 48" maximum sill height
- Window wells require minimum 3'x3' but must permit full opening of window. Ladder escape required when height over 48" to top of egress pit.



## DRIVEWAY & CULVERT PERMITS

South Dakota DOT, Minnehaha County, and eleven townships require driveway or culvert permits for new driveways and approaches. These permits must be obtained prior to the issuance of a building permit.

### *State*

Brian VanDam 367-5680  
 Department of Transportation (SDDOT)  
 5316 W 60<sup>th</sup> St. N. Sioux Falls, SD 57105

### *County*

367-4316  
 Minnehaha County Highway Department  
 2124 E. 60<sup>th</sup> St. N. Sioux Falls, SD 57104

### *Township Officers*

#### **Benton Township**

David Vinzant 528-3642  
 Ryan Andersen 528-3261  
 Jeff McAreavey 941-3297

#### **Highland Township**

Loren Konda 360-0372  
 Jeff Frerk 321-1813  
 Tom Elverson 359-9787

#### **Split Rock Township**

Rich Steffen 366-7999  
 Matt Staab 359-1115  
 Marvin Manifold 351-0261

#### **Brandon Township**

Thomas Brown 366-6735  
 Scott Trip 759-7941  
 Jason Metzger 231-0254

#### **Humboldt Township**

Thad Stofferahn 366-9055  
 Steven Lias 366-9853  
 Justin Wenzlaff 261-3450

#### **Sverdrup Township**

Joel Hazel 351-5192  
 Wayne Mohr 941-8053  
 Rocky Schreurs 351-3384

#### **Dell Rapids Township**

Kevin Schnieder 366-6769  
 Eric Fiegen 366-5117  
 Steve Scholton 595-2578

#### **Logan Township**

Kevin Brown 941-8207  
 Ken Siemonsma 360-8305  
 Gerome Geraets 929-6875

#### **Taopi Township**

Robert Sando 310-3428  
 James Willard 446-3833  
 Don Koopman 446-3450

#### **Edison Township**

Wayne Liester 360-5463  
 John Bly 351-0880  
 Dale Zweep 366-6859

#### **Mapleton Township**

Don Ahlschager 359-2044  
 William Rishling 371-6019  
 Jerome Thuringer

#### **Wall Lake Township**

Tim Slowey 360-6393  
 Thomas Spisak 940-9349  
 Glen Shade 366-2915

#### **Grand Meadow Township**

Dan Kistler 940-2110  
 Don Gelderman 528-6639  
 Charlie Jones 446-3577

#### **Red Rock Township**

Kevin Olson 359-2454  
 Eric Kientopf 201-5612  
 Michael Scholten 757-6843

#### **Wayne Township**

Keith TerMeer 201-1055  
 John Elsinger 366-8317  
 Patrick Doyle 366-6847